



HEDA SHELVES



HEDA SHELVES

广州禾达货架有限公司
Guangzhou HEDA Shelves Co., Ltd

Showroom Address: XinGangDong Road, HaiZhu District, Guangzhou City (Metro Pazhou station D)
展厅地址: 广州市海珠区新港东路会展南四路183号2楼 (地铁琶洲站D出口)

Factory Address: No.3 XiaBo LeHua Road, LuoCun ShiShan Town, Nanhai District, FoShan City,
GuangDong Province
工厂地址: 广东省佛山市南海区狮山镇罗村下柏乐华路三号

Tel: +86 20 34091098

座机: +86 20 34091098

Cell: +86 181 24246657

电话: +86 181 24246657

Web: www.hedashelves.com

网址: www.hedashelves.com

Email: heda@hedashelf.cn

邮箱: heda@hedashelf.cn



Guangzhou HEDA Shelves Co., Ltd

CONTENTS

- 01 About HEDA Shelves
- 02 HEDA Shelves Culture
- 03 Production Procedure
- 04 Container Loading Inspection
- 05 Light Duty Rack
- 07 Medium Duty Rack
- 08 Pallet Rack
- 09 Beam & Upright
- 11 Mezzanine Rack
- 13 Drivein Rack
- 14 Shuttle Rack
- 15 Push Back Rack
- 16 Gravity Rack
- 17 Cantilever Rack

About HEDA Shelves



Guangzhou HEDA Shelves Co., Ltd was founded in 2001. And located in Pazhou - the Exhibition Base of Chinese import and Export Fair Complex, is a professional company specializing in designing, manufacturing, selling and installing all types of display and storage shelves. We specialize in designing manufacturing, selling and installing all types of display stand, storage shelves and supermarket equipments, etc.

Up till now, our factory has workshops occupying a floor area of more than 22000 square meters and 120 workers, Our scientific design, delicate workmanship satisfactory quality and reasonable price make our corporate image perfect!

We can ensure you the first-class service, management and products. Our big factory, advanced facilities and professional workmanship ensure our further improvement. We have made various fashionable and creative shelves for different well-known brand customers, Our products are very popular in Southeast Asia, Japan, America, Canada, Australia and Europe. We have gained great credit from our foreign customers

We serve clients with the consistent principle of "Best Quality, Durable Structure, Perfect Design and Customer Satisfaction". Scientific designs, delicate workmanship, reasonable prices and the best services make our perfect corporate image

Our development lies on your active participation and sincere trust, and we will make every effort for further growth. For your support, we will move forward and further, to be the perfect shelf manufacturer and your best business partner!



HEDA Shelves Culture

Vision:

To become a sustainable and internationally recognized company.

Mission:

To pursue excellence in quality, deliver professional services, and create satisfaction with dedication.

Core Values:

Customer First | Unity | Openness | Professionalism | Passion



Production Procedure



Container Loading Inspection



Light Duty Rack



Length	Width	Height	Load Capacity
700mm	300mm	1520/1830mm	150kg/200kg
900mm	400mm	1520/1830mm	150kg/200kg
1200mm	500mm	1520/1830mm	150kg/200kg

Length	Width	Height	Load Capacity
1200mm	400mm	2000mm	200kg
1500mm	500mm	2500mm	300kg
2000mm	600mm	3000mm	500kg

Medium Duty Rack

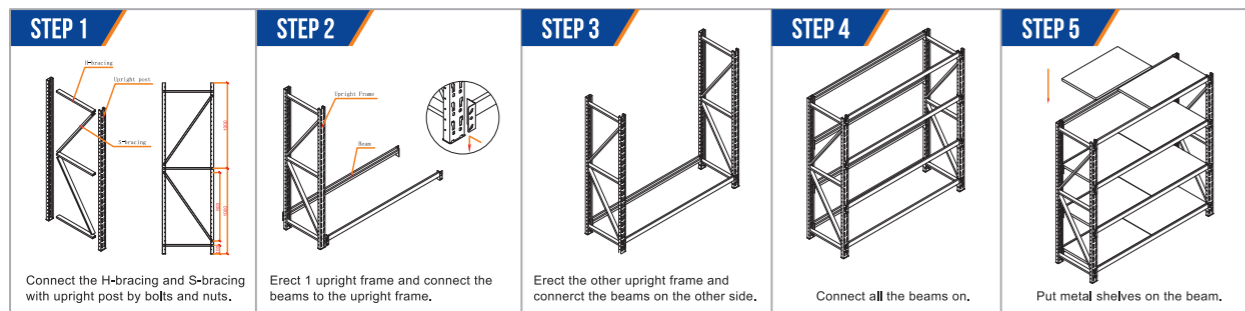

Length	Width	Height	Load Capacity
1200mm	400mm	2000mm	200kg
1500mm	500mm	2500mm	300kg
2000mm	600mm	3000mm	500kg

Pallet Rack

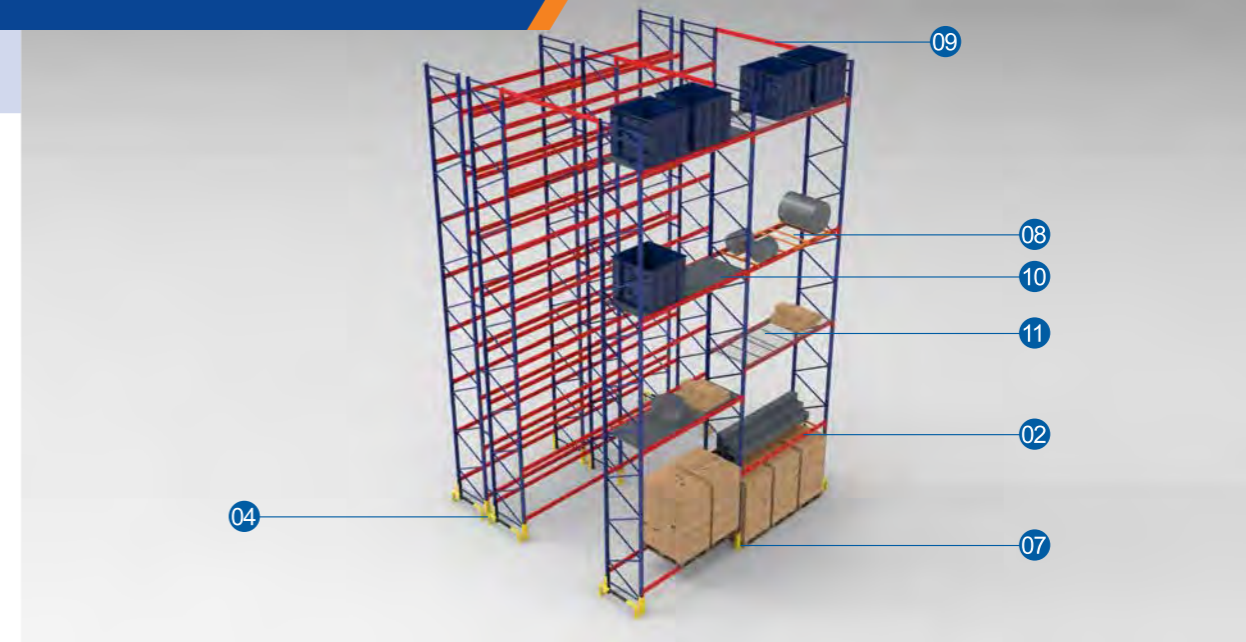

1. Frame
2. Beam
3. Safety Locking Mechanism
4. Frame Union
5. Anchor Bolts
6. Upright Protector
7. Lateral Protection Barrier
8. Cross Bracing Set
9. Top Portal Tie
10. Galvanised Picking Shelf
11. Mesh Shelf



Beam & Upright

Medium and light weight



50x60mm 50x70mm 50x80mm

Heavy duty upright



90x70mm 100x70mm 120x90mm

P-beam



60x40mm 80x40mm 100x40mm

Box Beam

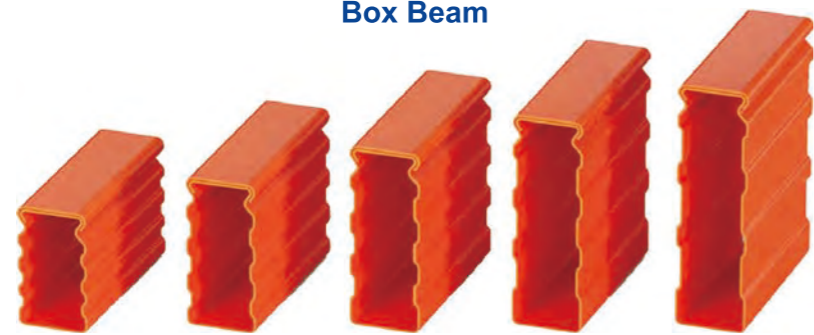

80x45mm 100x45mm 120x45mm 140x45mm 160x45mm

Beam Load-bearing coefficient table

Section HxB	Length(mm) / Load Capacity(kgf)											Surface (mm)
	1000	1500	2000	2300	2500	2700	3000	3300	3500	3800	4000	
Box Beam												
80*45*1.5	6206	2758	1552	1173	993	851	690	570	507	430	388	290
100*45*1.5	9748	4332	2437	1843	1560	1337	1083	895	796	675	609	330
120*45*1.5	14946	6643	3736	2825	2391	2050	1661	1372	1220	1035	934	370
140*45*1.5	21503	9557	5376	4065	3440	2950	2389	1975	1755	1489	1344	410
160*45*1.5	29535	13126	7384	5583	4726	4051	3282	2712	2411	2045	1846	450
Stacked Box Beam												
100+80	42397	18843	10599	8015	6784	5816	4711	3893	3461	2936	2650	
100+100	54306	24136	13576	10266	8689	7449	6034	4987	4433	3761	3394	
120+100	68691	30529	17173	12985	10991	9423	7632	6308	5607	4757	4293	
120+120	84627	37612	21157	15998	13540	11609	9403	7771	6908	5861	5289	
140+120	103305	45913	25826	19528	16529	14171	11478	9486	8433	7154	6457	
140+140	123769	55008	30942	23397	19803	16978	13752	11365	10104	8571	7736	
160+140	147263	65438	36809	27833	23558	20197	16360	13520	12019	10196	9202	
Square tube beam												
80*45*1.5	3889	1728	972	735	622	533	432	357	371	269	243	250
100*45*1.5	6299	2799	1575	1191	1008	864	700	578	514	436	394	290
120*45*1.5	9954	4424	2488	1882	1593	1365	1106	914	813	689	622	330
140*45*1.5	12213	5428	3053	2309	1954	1675	1357	1121	997	846	763	370
160*45*1.5	18441	8196	4610	3486	2951	2530	2049	1693	1505	1277	1153	410

Mezzanine Rack

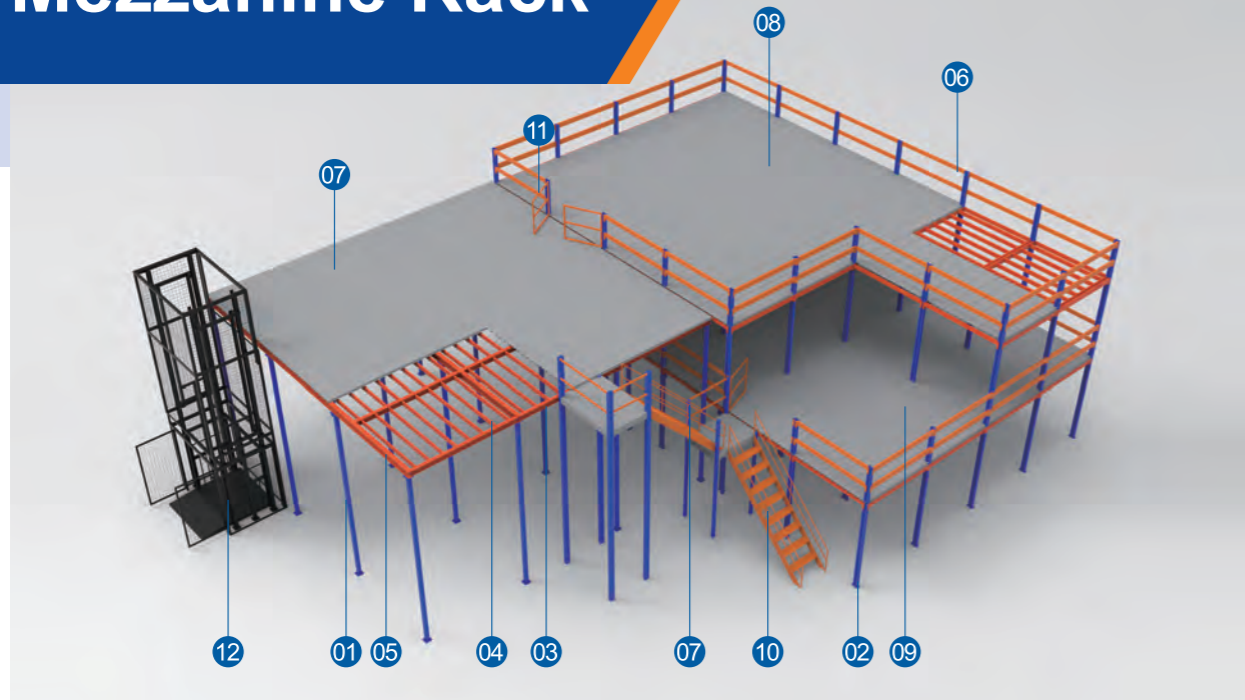

- 1. Single Upright
- 2. Double Upright
- 3. Main Beam
- 4. Crossing Beam
- 5. Vice Beam
- 6. Guard Bar
- 7. Wooden Floor
- 8. Galvanized Floor
- 9. Wire Mesh
- 10. Ladder
- 11. Swing Gate

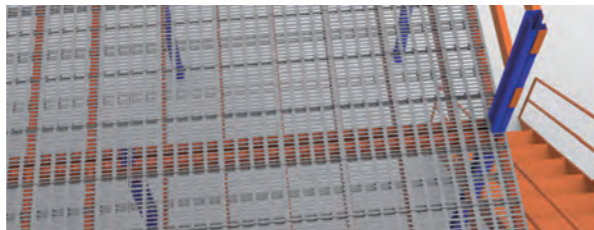
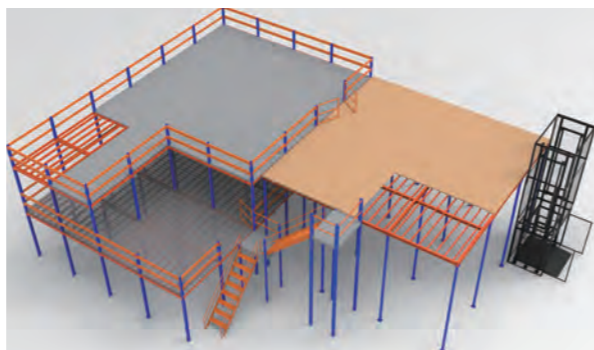

HEDA SHELVES

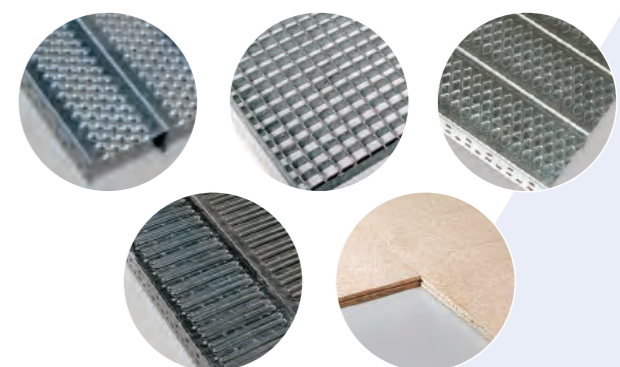
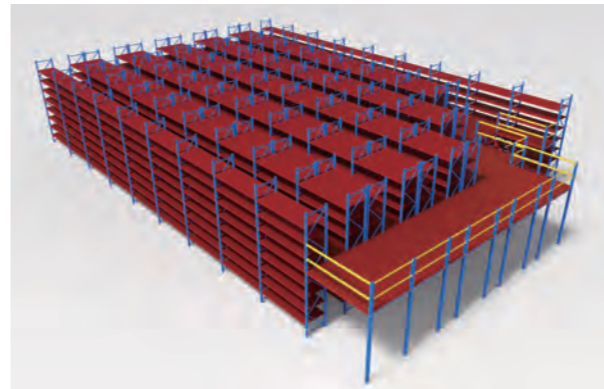
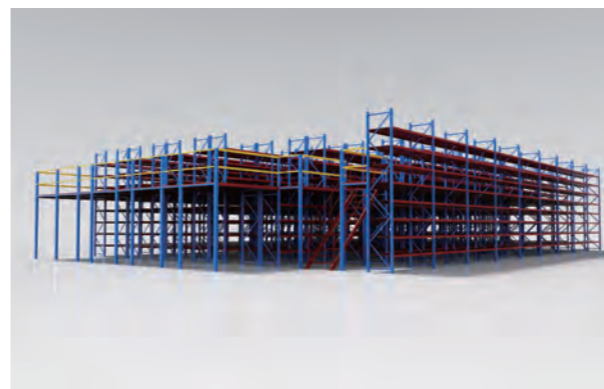
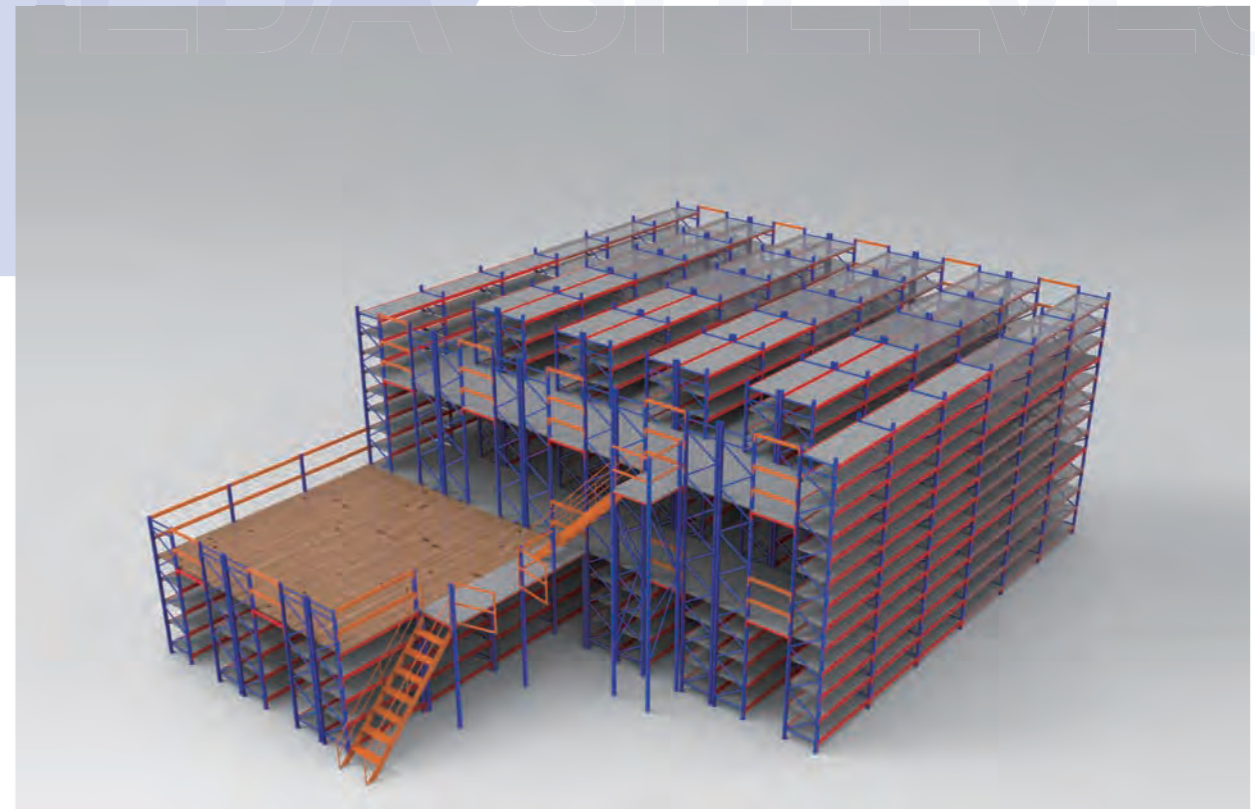

Drive in Rack

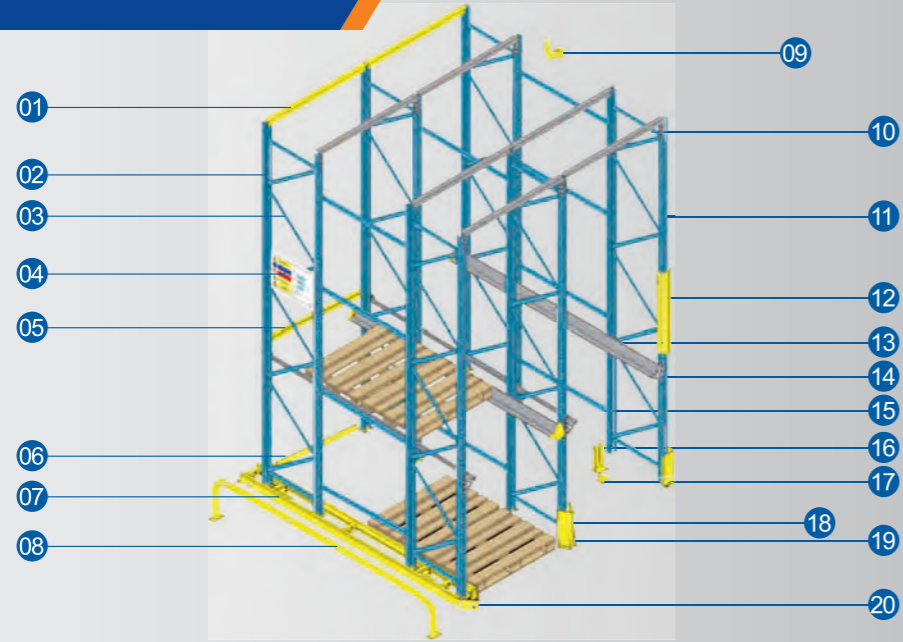

- | | |
|--------------------------|----------------------|
| 1. Top Beam | 11.Upright Post |
| 2. Frame | 12.Upright Protector |
| 3. Bracing | 13.Pallet Rail |
| 4. Load Notice | 14.Entry Guide |
| 5. Back Stop | 15.Double Support |
| 6. Floor Level Back Stop | 16.Shim |
| 7. Forklift Guide Rail | 17.Base Fcet |
| 8. End Barrier | 18.Column Guard |
| 9. Locking Pin | 19.Holding Down Bolt |
| 10.Single Support | 20.Rail Protector |



Shuttle Rack



Racking Components

- | | |
|--------------------------|----------------------------|
| 1. Column | 8. Rail Bracket |
| 2. Foot Plate | 9. Rail |
| 3. Adjustable Foot Stand | 10. Lateral Bracing |
| 4. Horizontal Bracing | 11. Post Guard |
| 5. Diagonal Bracing | 12. Forklift Stopper Plate |
| 6. Row Spacer | 13. Shuttle Car |
| 7. Supported Beam | 14. Remote Control |



Push back Rack



- 1. Frame
- 2. Beam
- 3. Rail
- 4. Trolley
- 5. Rail Support
- 6. Trolley Occupancy Indicator
- 7. Pallet Centraliser



Gravity Rack

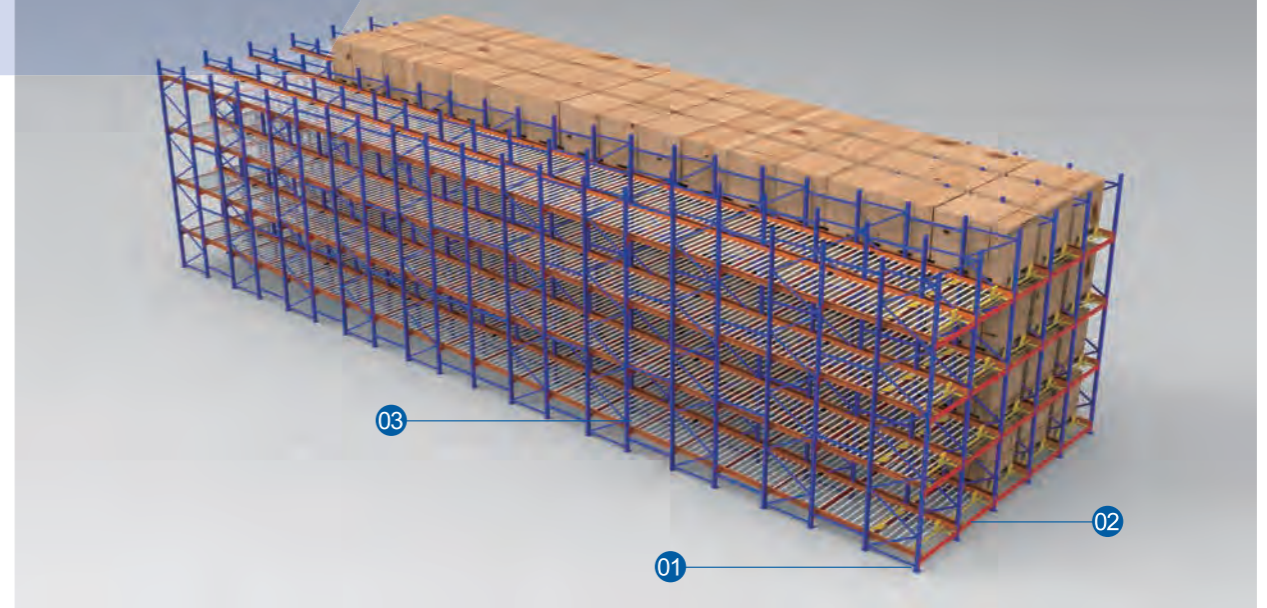

- 1. Frame
- 2. Beam
- 3. Rail

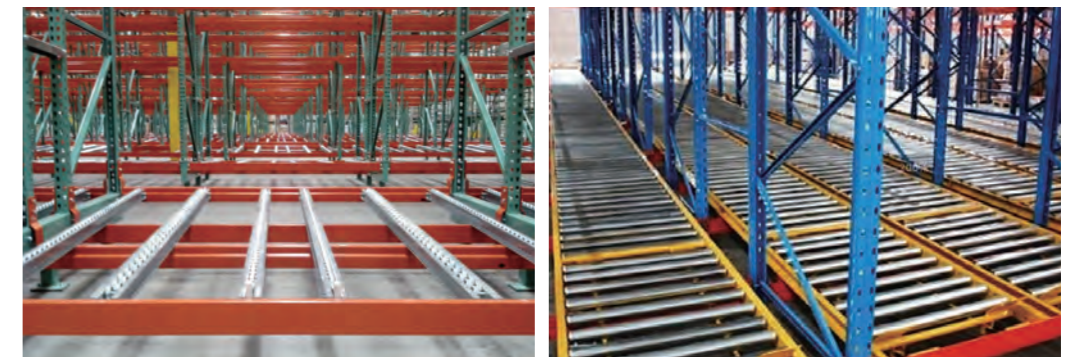

Cantilever Rack



Cantilever racks are being used for storing tubular products, structure products, section aluminum and many products with long and big size. Materials are stored and fixed on the arms by side forklifts or stacker cranes. This type is suitable for the warehouses with limited space and low height and widely being used in mechanical industries and supermarket of building materials.

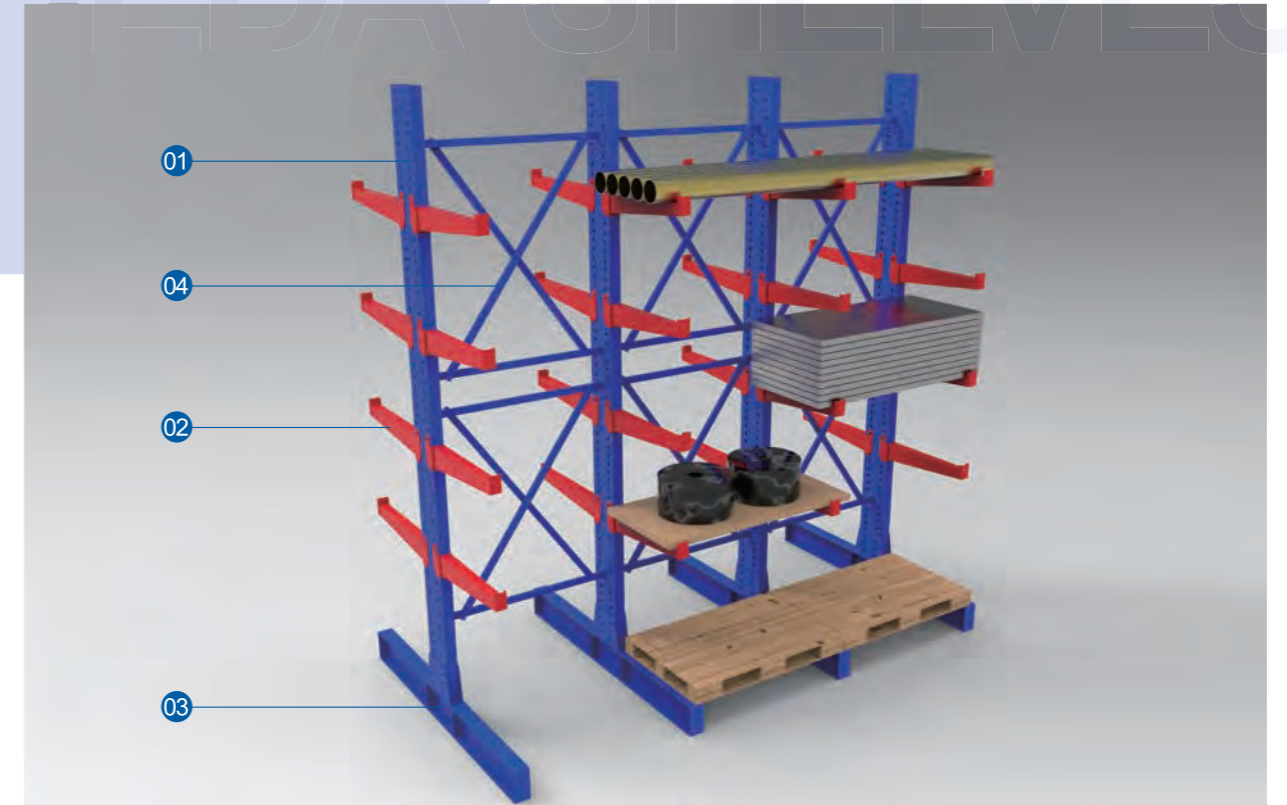
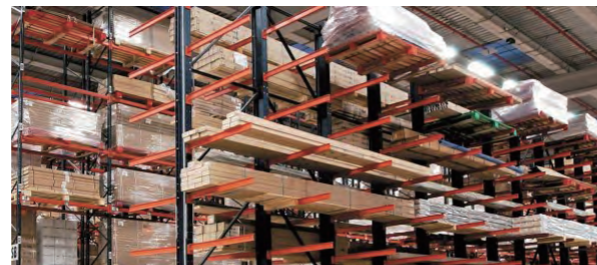

1. Upright
2. Arms
3. Base
4. Cross Bracing



Accessories Series

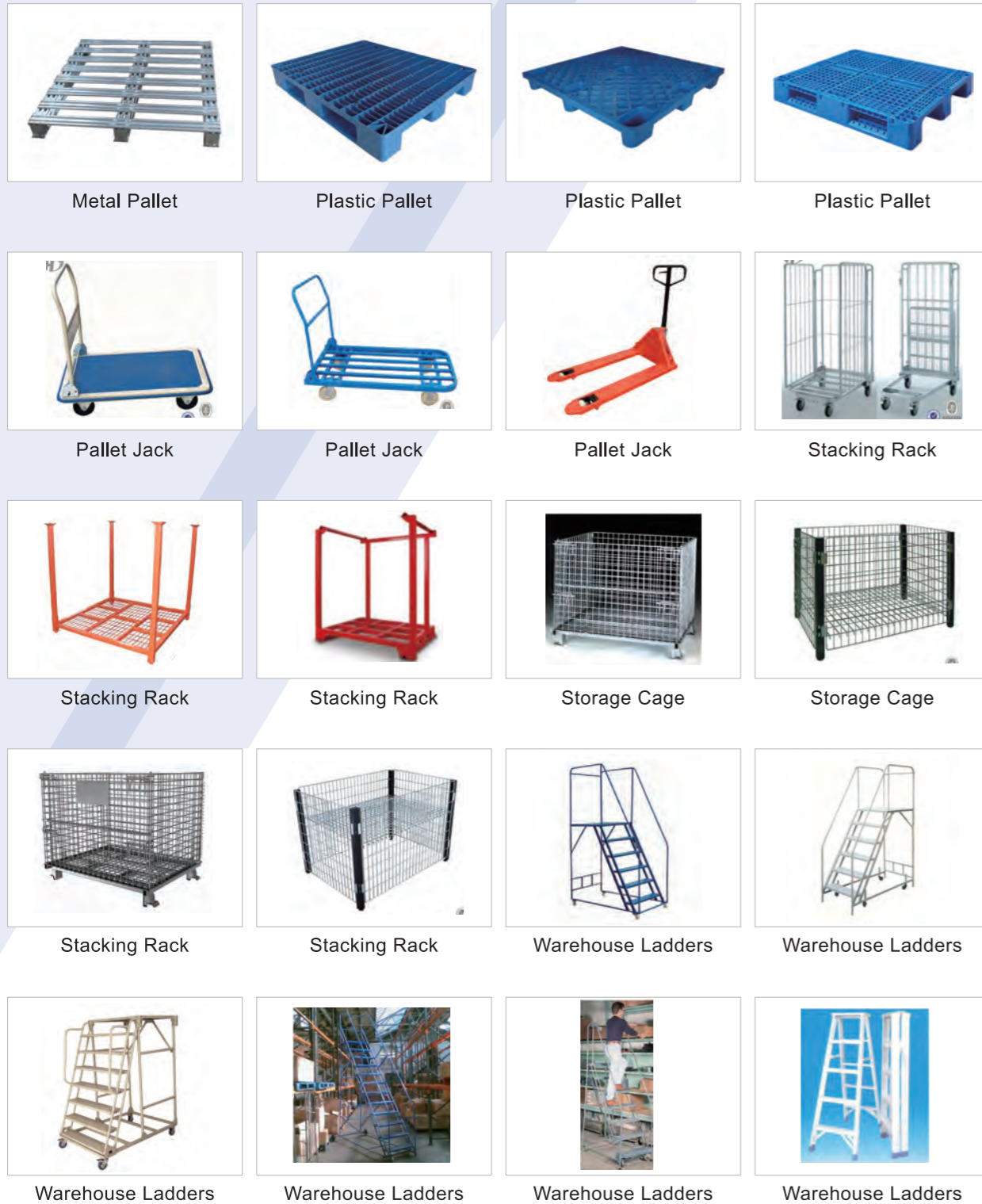

Our Customers

